

Каталог продукции CAT M.Zipperer

По вопросам продаж и поддержки обращайтесь:

Алматы (727)345-47-04
Ангарск (3955)60-70-56
Архангельск (8182)63-90-72
Астрахань (8512)99-46-04
Барнаул (3852)73-04-60
Белгород (4722)40-23-64
Благовещенск (4162)22-76-07
Брянск (4832)59-03-52
Владивосток (423)249-28-31
Владикавказ (8672)28-90-48
Владимир (4922)49-43-18
Волгоград (844)278-03-48
Вологда (8172)26-41-59
Воронеж (473)204-51-73
Екатеринбург (343)384-55-89

Иваново (4932)77-34-06
Ижевск (3412)26-03-58
Иркутск (395)279-98-46
Казань (843)206-01-48
Калининград (4012)72-03-81
Калуга (4842)92-23-67
Кемерово (3842)65-04-62
Киров (8332)68-02-04
Коломна (4966)23-41-49
Кострома (4942)77-07-48
Краснодар (861)203-40-90
Красноярск (391)204-63-61
Курск (4712)77-13-04
Курган (3522)50-90-47
Липецк (4742)52-20-81

Магнитогорск (3519)55-03-13
Москва (495)268-04-70
Мурманск (8152)59-64-93
Набережные Челны (8552)20-53-41
Нижний Новгород (831)429-08-12
Новокузнецк (3843)20-46-81
Ноябрьск (3496)41-32-12
Новосибирск (383)227-86-73
Омск (3812)21-46-40
Орел (4862)44-53-42
Оренбург (3532)37-68-04
Пенза (8412)22-31-16
Петрозаводск (8142)55-98-37
Псков (8112)59-10-37
Пермь (342)205-81-47

Ростов-на-Дону (863)308-18-15
Рязань (4912)46-61-64
Самара (846)206-03-16
Санкт-Петербург (812)309-46-40
Саратов (845)249-38-78
Севастополь (8692)22-31-93
Саранск (8342)22-96-24
Симферополь (3652)67-13-56
Смоленск (4812)29-41-54
Сочи (862)225-72-31
Ставрополь (8652)20-65-13
Сургут (3462)77-98-35
Сыктывкар (8212)25-95-17
Тамбов (4752)50-40-97
Тверь (4822)63-31-35

Тольятти (8482)63-91-07
Томск (3822)98-41-53
Тула (4872)33-79-87
Тюмень (3452)66-21-18
Ульяновск (8422)24-23-59
Улан-Удэ (3012)59-97-51
Уфа (347)229-48-12
Хабаровск (4212)92-98-04
Чебоксары (8352)28-53-07
Челябинск (351)202-03-61
Череповец (8202)49-02-64
Чита (3022)38-34-83
Якутск (4112)23-90-97
Ярославль (4852)69-52-93

Россия +7(495)268-04-70

Казахстан +7(727)345-47-04

Беларусь +(375)257-127-884

Узбекистан +998(71)205-18-59

Киргизия +996(312)96-26-47

эл.почта: cgb@nt-rt.ru || сайт: <https://cat-ing.nt-rt.ru/>

An overhead stirrer with a digital display and control panel is shown in the foreground. In the background, a person wearing blue gloves is using a pipette to transfer liquid into a beaker. The scene is set in a laboratory with various glassware.

Overhead Stirrers & Homogenizers

Page **04**

A magnetic stirrer with a digital display and control panel is shown in the foreground. In the background, a person wearing blue safety goggles is looking intently at a piece of laboratory equipment. The scene is set in a laboratory.

Magnetic Stirrers & Hotplates

Page **18**

A shaker or mixer with a digital display and control panel is shown in the foreground. In the background, a person wearing blue gloves is using a pipette to transfer liquid into a beaker. The scene is set in a laboratory.

Shakers & Mixers

Page **34**

A dispensing system with a digital display and control panel is shown in the foreground. In the background, a person wearing blue gloves is using a pipette to transfer liquid into a beaker. The scene is set in a laboratory.

Dispensing Systems

Page **42**

A laboratory automation system with a digital display and control panel is shown in the foreground. In the background, a person wearing blue gloves is using a pipette to transfer liquid into a beaker. The scene is set in a laboratory.

Laboratory Automation

Page **50**

CAT

Ingenieurbüro CAT, M. Zipperer GmbH

Dear Customer,

our Company Ingenieurbüro CAT, M. Zipperer GmbH develops since 1976 tailor-made individual solutions in the laboratory area. The product range extends from high-precision microdosage pumps to magnetic stirrers, shakers, dispersing devices, cell counters and robots for laboratory automation.

The completely different product areas, the development and manufacture of model airplanes for jet model flying, was added in 1998, with brand name „JetCat“. The fascination for jet model flying has remained unbroken ever since. Today, these engines are not only used in model flying, but also for exciting requirements in the industry, as well in universities or colleges. Our workforce with more than 100 employees ensures the consistent provision of comprehensive solutions that meet the individual requirements of our private and industrial customers.

In all our products as well as in our processes, we attach great importance to a high quality standard. Today, the company is managed by Dipl. Ing. Markus Zipperer and grows in both sectors.

All our products are fully designed and verified with a 3D-CAD system. The own CNC machine park allows besides the toolmaking a flexible production of milling and turning parts of all kind. Plastic parts are manufactured on own plastic injection machines. The precise welding of thin-walled metal parts takes place on our own laser welding machines.

The „short ways“, the close cooperation between development engineers and production, make us especially efficient. New ideas and customer requests can be quickly implemented and tested in practice.

Overhead Stirrers

- **Stirrers for high viscosity applications**
- **Overheat & overload protection**
- **Backlit display**
- **Analog & Digital Interface**
Switch-off timer
- **Control software available**



R 100

Powerful microprocessor controlled stirrer for heavy duty jobs. A multi-step safety system carries out a self test of all safety functions and detects and protects against overload as well as overtemperature. The bright backlit digital display shows all relevant system data (power input, power output and torque) plus simultaneous display of set and actual motor speed. The display also allows for readout of the absolute or relative torque measurements as well as the power output in watts at the shaft. Torque limits, maximum and minimum motor speeds are programmable.

The unit is supplied with an RS232-interface for computer control. There is also an analogue input for easy remote speed control and analogue output for recorder as well as a programmable switch-off timer.



Technical Data	R 100C	R 100CL	R 100CT	R 100SD
Speed range [1/min]	40 – 2000	30 – 1100	10 – 500	40 – 2000
Torque, max. [Ncm]*	150	250	600	100
Stirring quantity, max. (H ₂ O) [l]	200	200	200	200
Viscosity, max. [mPas]	60.000	70.000	100.000	60.000
Chuck range [mm]	1 – 10.5	1 – 10.5	1 – 10.5	1 – 10.5
Power supply [V]	See: order information	See: order information	See: order information	See: order information
PC interface	RS 232	RS 232	RS 232	-
Weight [kg]	4.7	4.7	5.5	4.7
Dimensions [WxD mm]	78 x 200 x 230	78 x 200 x 230	78 x 200 x 250	78 x 200 x 230
Protection class according to DIN EN 60529	IP42	IP42	IP42	IP42

* periodic duty type S3 30% (short-time Duty)

Order Information

	Part Number			
230 VAC / 50Hz, EU plug (Type F)	60218-0000	60315-0000	60314-0000	60313-0000
115 VAC / 60Hz, USA plug (Type B)	60218-0001	60315-0001	60314-0001	60313-0001
230 VAC / 50Hz, UK plug (Type G)	60218-0003	60315-0003	60314-0003	60313-0003



Accessories	Part Number	Description
Pedestal Stand	60491-0010	Plate stand (green), dimensions: 330 x 200 mm incl. tripod rod, Ø 16 mm, length 690 mm
Special clamp	60495-0000	Clamp to fix the R 100 stirrer to the U-Stand
„Jumbo“ clamp	8B005650	Clamp to fix stirring shaft protector to the U-Stand
Stirring shaft protector	60618-0060	Protection of shaft for stirrer
RS232 interface cable	30275-0051	Interface cable 1.8m for connection to PC
USB to RS232 adapter	30244-0001	USB adapter for connection PC to RS232 interface of R 100
Software	Upon request	Control software for stirrer

Overhead Stirrers

- **Small powerful overhead stirrers**
- **Digital rpm display**
- **PC interface**
- **Maintenance-free brushless motor**
- **Low voltage power supply**



R 20 / R 60 / R 16

R 20 / R 60: A robust stirrer motor with up to 60 Ncm torque, programmed soft start and soft stop motor control, RS232 interface, brushless 60 W motor, quick release chuck and hollow shaft for inserting and fixing tools up to 10 mm. Maintenance-free brushless motor allowed long time using of device.

The device is suitable for light to medium viscosity stirring tasks.

R 16: Convenient and long lasting small laboratory overhead stirrer with electronic feedback speed control. Comes with a mounting rod which can be attached to any laboratory stand. Chuck for stirring elements of 4 mm or 6 mm diameter. We offer a special designed stirring paddle in stainless steel which can be ordered together with the stirrer.



Technical Data	R 20D-PC	R 60D-PC	R 16
Speed range [1/min]	50 – 2000	20 - 800	50 – 1000
Torque, max. [Ncm]	20	60	4
Stirring quantity, max. (H2O) [l]	30	100	10
Viscosity, max. [mPas]	10.000	50.000	100
Chuck range [mm]	1 – 10.5	1 – 10.5	6.0 fix
Power supply [V]	24VDC / 60W	24VDC / 60W	24VDC / 25W
PC interface	RS 232	RS 232	-
Weight [kg]	1.3	1.3	0.7
Dimensions [WxHxD mm]	68 x 165 x 130	68 x 165 x 130	67 x 105 x 121
Protection class according to DIN EN 60529	IP42	IP42	IP42

Order Information

Part Number

24VDC / 25W			60213-0050
Stirrer incl. Power supply, 24VDC/60W	60214-0055	60214-0065	
Power cable, EU-plug (Type F)	30732-0057	30732-0057	
Power cable, USA-plug (Type B)	30200-0081	30200-0081	
Power cable, UK-plug (Type G)	30200-0080	30200-0080	

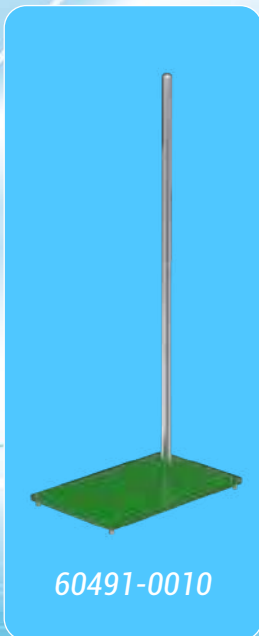

Accessories	Part Number	Description
Pedestal Stand	60491-0010	Plate stand (green), dimensions: 330 x 200 mm incl. tripod rod, Ø 16 mm, length 690 mm
Crossover clamp budget	60492-0000	Gray Aluminum painted clamp. For support rod: 6-12 mm
Crossover clamp standard	60492-0050	Stainless steel clamp. For support rod: 6-12 mm
Crossover clamp with 2 clamp levers	60492-0020	Stainless steel clamp with clamp levers. For support rod: 6-12 mm
Stirring shaft protector	60618-0060	Protection of shaft for stirrer
PC-Connection cable	50276-0005	PC-Connection cable (1m)
RS232 extension cable	30275-0051	RS 232 extension cable 1.8 m
USB to RS232 adapter	30244-0001	USB adapter for connection PC to RS232 interface to stirrer
Software	Upon request	Control software for stirrer

Overhead Stirrers

- **Universal laboratory overhead stirrers**
- **Overheat & overload protection**
- **Keyless chuck**



R 18 / R 50

The universal laboratory overhead stirrer series. The stirring motors are well suited for all stirring needs of moderate viscosity in any laboratory, either professional or classroom. The use of instrument is advantageous where the speed adjustment of stirring processes has to be reproducible.



R 18

R 50

Technical Data

Speed range [1/min]	100 – 2000	50 – 1600
Torque, max. [Ncm]	18	50
Stirring quantity, max. (H2O) [l]	20	100
Viscosity, max. [mPas]	8.000	30.000
Chuck range [mm]	1 – 10.5	1 – 10.5
Power supply [V]	See: order information	See: order information
PC interface	-	-
Weight [kg]	2.2	2.3
Dimensions [WxD mm]	65 x 200 x 120	65 x 200 x 120
Protection class according to DIN EN 60529	IP32	IP32

Order Information

Part Number

230 VAC / 50Hz, EU plug (Type F)	60214-0000	60215-0000
115 VAC / 60Hz, USA plug (Type B)	60214-0001	60215-0001
230 VAC / 50Hz, UK plug (Type G)	60214-0003	60215-0003

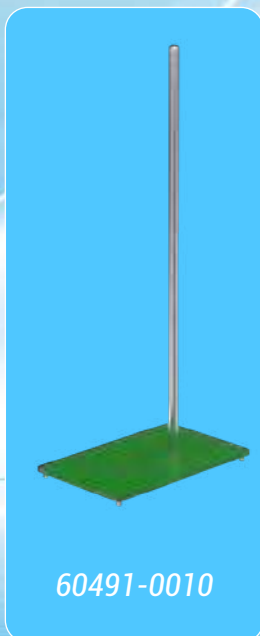

Accessories	Part Number	Description
Pedestal Stand	60491-0010	Plate stand (green), dimensions: 330 x 200 mm incl. tripod rod, Ø 16 mm, length 690 mm
Crossover clamp budget	60492-0000	Gray aluminum painted clamp. For support rod: 6-12 mm
Crossover clamp standard	60492-0050	Stainless steel clamp. For support rod: 6-12 mm
Stirring shaft protector	60618-0060	Protection of shaft for stirrer
RS232 interface cable	30275-0051	Interface cable 1.8 m for connection to PC
USB to RS232 adapter	30244-0001	USB adapter for connection PC to RS232 interface of R 100
Software	Upon request	Control software for stirrer

Overhead Stirrer Accessories



60617-0050



60617-0060



60618-0050

Part No.

60617-0050	Dissolver \varnothing 100 mm + shaft
60617-0000	Dissolver \varnothing 100 mm
60617-0010	Dissolver shaft \varnothing 36 mm
60618-0000	Dissolver shaft \varnothing 8x350 mm
60617-0060	Dissolver \varnothing 36 mm + shaft

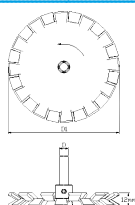

Part No.

60618-0050	Stirring blade + shaft
60619-0000	Stirring blade (L = 90 mm)
60619-0010	Stirring blade (L = 150 mm)
60618-0000	Stirring shaft (\varnothing 8x350 mm)

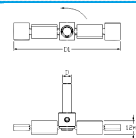



8B00950400

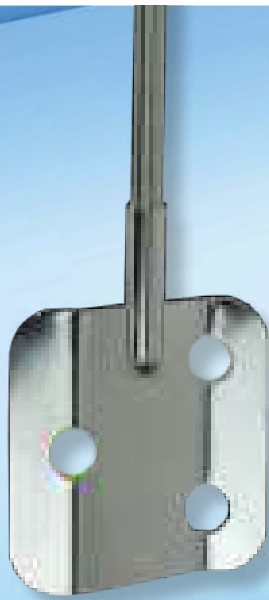

8B00940400



8B00900000

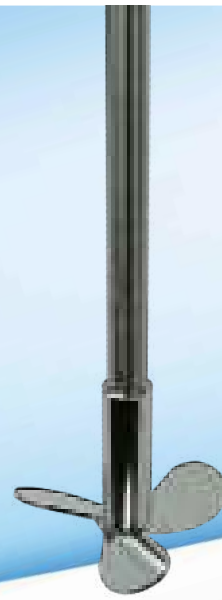

8B00910000

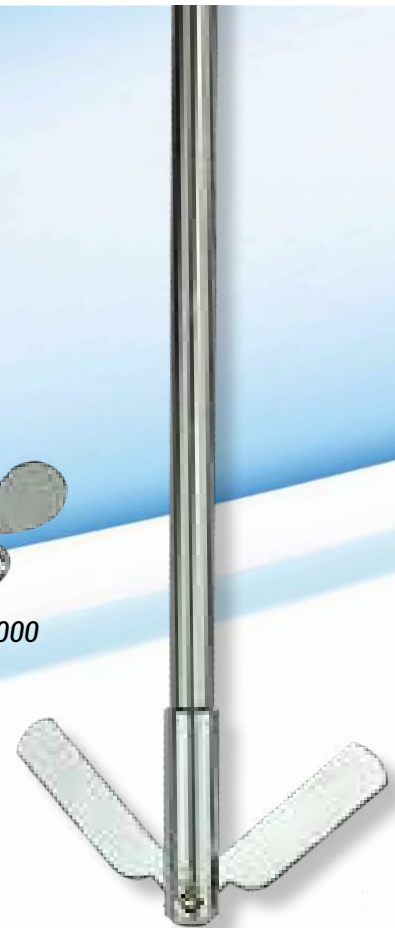

8B00921000

Part No.	Blade Stirrer	Length including blade	Diameter of rod	Diameter of blade
8B00970000		300 mm	6 mm	50 mm
8B00970300		300 mm	8 mm	50 mm
8B00970400		400 mm	8 mm	50 mm
8B00970500		500 mm	8 mm	50 mm

Part No.	Blade Stirrer	Length including blade	Diameter of rod	Diameter of blade
8B00940400		400 mm	8 mm	70 mm
8B00940800		500 mm	10 mm	70 mm
8B00950400		400 mm	8 mm	70 mm
8B00950800		500 mm	10 mm	70 mm

Part No.	Propeller Stirrer	Length including blade	Diameter of rod	Diameter of blade
8B00910000		300 mm	6 mm	50 mm
8B00910300		400 mm	8 mm	50 mm
8B00910400		500 mm	8 mm	50 mm
8B00910500		400 mm	8 mm	70 mm
8B00911000		500 mm	10 mm	100 mm
8B00911400		300 mm	6 mm	50 mm
8B00900400		400 mm	8 mm	50 mm
8B00901000		400 mm	8 mm	100 mm

Part No.	Centrifugal Stirrer	Length including blade	Diameter of rod	Diameter of blade
8B00921000		400 mm	8 mm	90/15 mm

Homogenizers

- **Powerful drive motors**
- **Stainless steel dispersing tools**
- **Ceramic sealed tools available**
- **Suitable for usage in food applications**



High-quality dispersing systems.

We offer a range of drive motors, from small hand-held to high-power motor with variable speed control to start at low speed without splashing.

X 120: Hand-held or stand mounted, high-speed drive motor for small volumes, from 2.0 ml.

Unidrive X 1000: General-purpose drive motor for most of dispersing tasks. The device is available with LCD display.

X 1740: Especially designed for heavy-duty laboratory and pilot plant tasks.



Technical Data	X 120	X 1000 Unidrive	X 1000D Unidrive	X 1740
Speed range [1/min] 230V-Version	10.000 – 33.000	4.000 – 35.000	4.000 – 35.000	2.500 – 23.000
Speed range [1/min] 115V-Version	5.000 – 32.000	4.000 – 35.000	4.000 – 35.000	2.500 – 23.000
Motor power [W]	140	1.050	1.050	1.800
Display	-	-	yes	-
Volume range, max. (H2O) [ml]	1.500	2.000	2.000	20.000
Noise without tool, max [dB]	86	78	78	87
Applicable Dispersing Tools	T 6 T 10 T 17	T 6 T 10 T 17 T 20 / G 20	T 6 T 10 T 17 T 20 / G 20	T 30 / G 30 T 40 / G 40
Power supply [V]	See: order information	See: order information	See: order information	See: order information
Weight [kg]	0.75	2.1	2.1	4.7
Dimensions [L x D mm]	220 x 53	290 x 75	290 x 75	360 x 100
Protection class according to DIN EN 60529	IP20	IP20	IP20	IP20

Order Information

Part Number

230 VAC / 50Hz, EU plug (Type F)	60404-0000	60402-0050	60406-0050	60408-0000
115 VAC / 60Hz, USA plug (Type B)	60404-0001	60402-0051	60406-0051	60408-0001

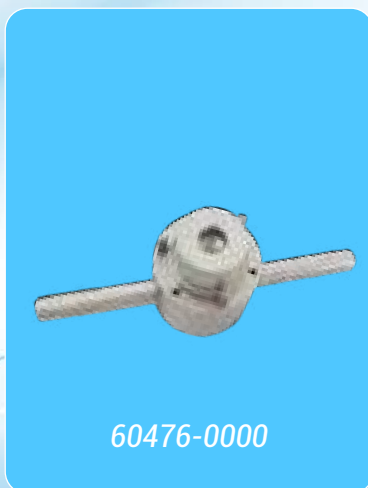
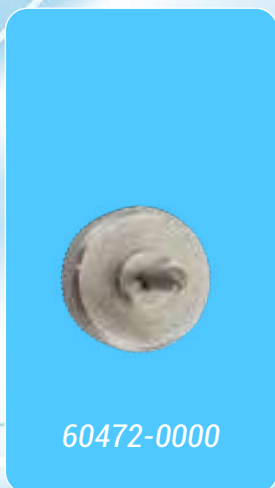

Accessories

Part Number

Description

Pedestal Stand	60491-0010	Plate stand (green), dimensions: 330 x 200 mm incl. tripod rod, Ø 16 mm, length 690 mm
Crossover clamp budget	60492-0000	Aluminium white coated clamp. For support rod: 6-12 mm
Crossover clamp standard	60492-0050	Stainless steel clamp. For support rod: 6-12 mm
Crossover clamp with 2 clamp levers	60492-0020	Stainless steel clamp with clamp levers. For support rod: 6-12 mm
Special clamp	60495-0000	Clamp to fix the X 1740 to the stand. For support rod: 12-35 mm
Universal key	60470-0000	Universal rotor wrench for tools T 6 – T 20 / G 20
Socket wrench	60471-0000	Socket wrench for all tools
Rotor wrench T10	60472-0000	Rotor wrench for T 10 only
Rotor wrench T 30	60476-0000	Rotor wrench for T 30 / G 30
Rotor wrench T 40	60477-0000	Rotor wrench for T 40 / G 40

Homogenizers



X 1000 Unidrive
X 1000D Unidrive



X 120



Please note that the maximum depth of immersion is:

fine **F**

low viscosity **N**

viscous **V**

knife **M**

T 6	T 10	T 17
 2,0 - 50 ml	 10,0 - 250 ml	 250 - 1500 ml
55 mm	150 mm	150 mm
 60420-000F	 60421-000F	 60426-000F
 60420-000N	 60421-000N	 60426-000N
 60420-000V	 60421-000V	 60426-000V
 60420-000M	 60421-000M	 60426-000M

X 1740



T 20	G 20	G 30	G 40
			
250 - 5000 ml		500 - 5000 ml	5000 - 20000 ml
200 mm	215 mm	280 mm	280 mm
			
60422-000F	60423-000F	60428-000F	60415-000F
			
60422-000N	60423-000N	60428-000N	60415-000N
			
60422-000V	60423-000V	60428-000V	60415-000V
			
	60423-000M	60428-000M	60415-000M

T = Shaft with PTFE bearing. This shaft type is used for standard application. (For liquid media like water, oil, etc.)

G = Shaft with slide seal ring. This shaft type is excellent for applications with aggressive respectively abrasive media and when pressure is applied.

Build your Dispersing System by selecting a Motor plus one Tool

Homogenizers

- **Smart In-line homogenizer**
- **Stainless steel housing**
- **Universal tube connectors**
- **Chamber cooling (DK 40)**



Flow-through chamber.

The DK series stainless steel flow-through chamber fit the shaft with ceramic seal. In-line units work according to the rotor-stator principle with high shear rates. Extremely fine distribution of solid particles (suspensions) and liquids in a basic liquid (emulsions) is achieved by the combined effect of different particle reduction effects using this system.

Pressure-rated for 0.7 to 2 bar.



Technical Data	DK 30	DK 30	DK 40
Flow rate (H2O) [L/min]	20.0 ¹	20.0 ¹	80.0 ¹
Chamber cooling	-	-	Yes
Applicable Driving motor	X 1000, X 1000D	X 1740	X 1740 ²
Applicable Dispersing Tools	G 20	G 30	GD 40 ³
Inlet and Outlet connectors, diameter [mm]	20.0	20.0	20.0
Cooling connectors, diameter [mm]	-	-	10.0
Weight [kg]	0.7	0.7	6.0
Dimensions [LxWxD/H mm]	120 x 85 x 50	120 x 85 x 50	410 x 200 x 160

¹ - depend of dispersing tool and driving motor combination

² - part must be ordered separately

³ - part is always assembled

Order Information	Part Number	
DK 30	60428-0000	-
DK 40-N	-	60429-000N
DK 40-V	-	60429-000V
DK 40-F	-	60429-000F

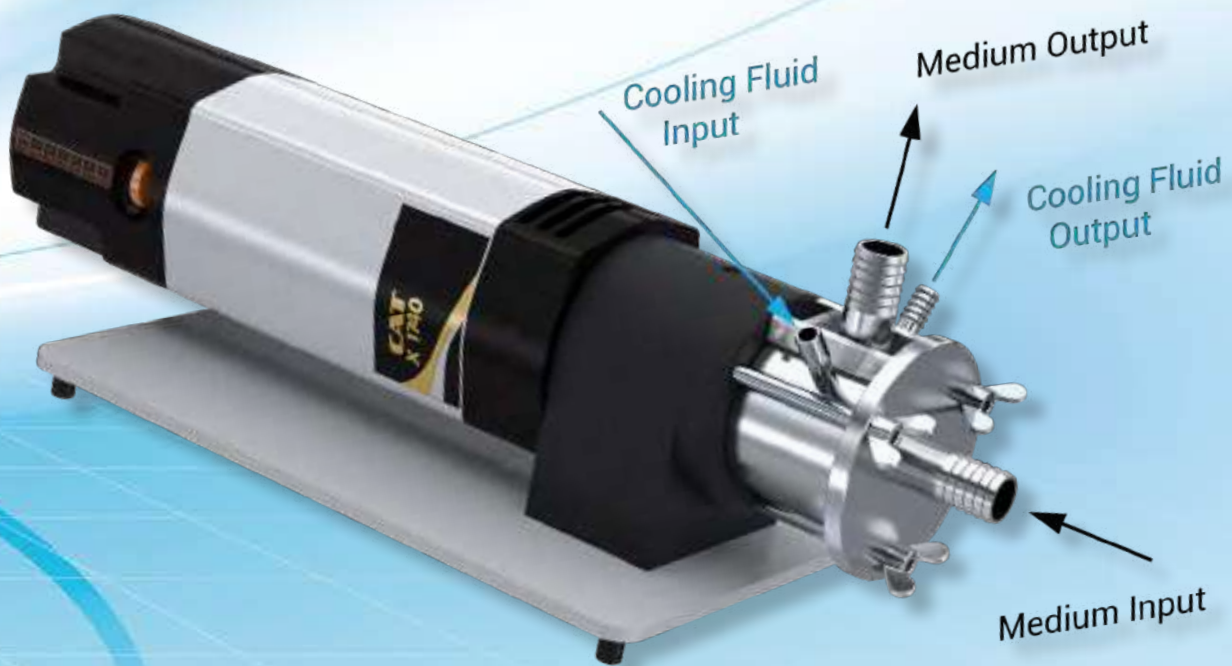

Magnetic Hotplate Stirrers

- **Magnetic hotplate stirrers for higher requirements**
- **Programmable multimer-function**
- **Programmable ramp-function**
- **Programmable safety temperature**
- **Control software available**



MCS 77 / MCS 78 / M 26G2

With modern microprocessor technology self monitoring and programmable magnetic stirrers found their way into today's labs. The RS485 interface provides for networking with other lab equipment or a computer. A 5-step timer system allows for generation of user-defined temperature and stirring profiles. Hotplate and probe temperature, motor speed and temperature slope can be defined for each timer step.

M 26G2 unit has been developed for discerning users who value safety as paramount in their laboratories. A second PT100 sensor can be connected to the M 26G2 to switch off the unit if preset safety temperature is reached.



Technical Data	MCS 77	MCS 78	M 26G2
Speed range [1/min]	60 – 1600	60 – 1600	60 – 1600
Temperature range [°C]	RT(+5°C) - 330	RT(+5°C) - 440	RT(+5°C) - 360
Heating power [W]	500	600	500
Heater plate diameter [mm]	○ 140	○ 130	○ 140
Heater plate	Eloxal	Ceran®	Eloxal
Temperature control accuracy [°C]	± 0,2 (with probe)	± 0,2 (with probe)	± 0,2 (with probe)
Stirring quantity, max. (H2O) [l]	10	10	10
Safety circuits	1	1	2
External probe connection	PT100 KTA	PT100 KTA	PT100 PT100 Duplex KTA
PC interface	RS485	RS485	RS485
Power supply [V]	See: order information	See: order information	See: order information
Weight [kg]	3.9	3.9	2.6
Dimensions [WxHxD mm]	180 x 115 x 250	180 x 115 x 250	145 x 110 x 220
Protection class according to DIN EN 60529	IP32	IP32	IP32

Order Information	Part Number		
230 VAC / 50Hz, EU plug (Type F)	60276-0050	60277-0050	60279-0000



Accessories	Part Number	Description
PT100	60278-0000	Temperature probe, diameter: 4 mm, sensor length: 240 mm
PT100 Duplex	60673-0000	Duplex temperature probe, diameter: 4 mm, sensor length: 240 mm
Probe support rod	60663-0000	Diameter: 8 mm, length: 350 mm
Probe clamp	8B005624	Stainless steel probe clamp
Clamp holder	60668-0000	Holder rod for probe clamp
RS485-RS232 adapter	61703-0050	Adapter for connection to RS232 PC interface (MCS)
RS485-RS232 adapter	61703-0000	Adapter for connection to RS232 PC interface (M26G2)
RS232 extension cable	30275-0051	RS 232 extension cable 1.8 m
USB to RS232 adapter	30244-0001	USB adapter for connection to PC
Software	Upon request	Control software for Magnetic stirrer

Magnetic Hotplate Stirrers

- **Hotplate magnetic stirrers for standard applications**
- **Programmable safety temperature**
- **External probe connection**
- **Control software available**



M 21 / M 22 / M 23

The mid range hotplate stirrers M 21, M 22 and M 23 feature direct display and set of plate, probe and safety temperatures on the front panel of the instrument. These hotplate stirrers all have superb performance such as soft-start for the stirring motor, PID control of the liquid and hotplate temperatures for fastest heat up time without overshoot and temperature stability, acid resistant epoxy-finished chassis and grade 304 stainless steel covers, combined with a stainless steel shroud between hotplate and cover to avoid the entrance of spills into the interior. All three models are available with RS485-interface which enables easy setting and readout of all relevant parameters.



Technical Data

	M 21	M 22	M 23
Speed range [1/min]	60 – 1600	60 – 1600	60 – 1600
Temperature range [°C]	RT(+5°C) - 350	RT(+5°C) - 380	RT(+5°C) - 500
Heating power [W]	500	500	600
Heater plate diameter / dimensions [mm]	○ 130	○ 140	□ 135 x 135
Heater plate	Stainless steel	Eloxal	Ceran®
Temperature control accuracy [°C]	± 1	± 1	± 1
Stirring quantity, max. (H ₂ O) [l]	10	10	10
Safety circuits	1	1	1
External probe connection	PT100 KTA	PT100 KTA	PT100 KTA
PC interface	RS485	RS485	RS485
Power supply [V]	See: order information	See: order information	See: order information
Weight [kg]	2.6	2.6	2.6
Dimensions [WxHxD mm]	145 x 110 x 210	145 x 110 x 210	145 x 110 x 210
Protection class according to DIN EN 60529	IP32	IP32	IP32

Order Information

Part Number

230 VAC / 50Hz, EU plug (Type F)	60361-0000	60362-0000	60363-0000
115 VAC / 60Hz, USA plug (Type B)	60361-0001	60362-0001	60363-0001

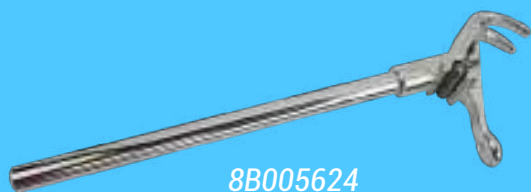

8B005624



60668-0000



60278-0000



61703-0000

Accessories

Part Number

Description

PT100	60278-0000	Temperature probe, diameter: 4 mm, sensor length: 240 mm
Probe support rod	60663-0000	Diameter: 8 mm, length: 350 mm
Probe clamp	8B005624	Stainless steel probe clamp
Clamp holder	60668-0000	Holder rod for probe clamp
RS485-RS232 adapter	61703-0000	Adapter for connection to RS232 PC interface
RS232 extension cable	30275-0051	RS 232 extension cable 1.8 m
USB to RS232 adapter	30244-0001	USB adapter for connection to PC
Software	Upon request	Control software for magnetic stirrers

Magnetic Hotplate Stirrers

- **Basic laboratory hotplate magnetic stirrers**
- **Robust stainless steel housing**
- **Very small footprint (ECM6)**



M 6 / ECM 6

Hotplate Stirrers for the daily Lab Routine

This group of compact, robust stirrers has been developed for general stirring tasks in today's busy laboratory. Analogue controlled hotplates, brushless motors with opto-electronic speed control, embedded heater coils, Ingenieurbüro CAT M. Zipperer GmbH splash-proof construction with stainless steel covers give a long term trouble-free life. Hotplate stirrers M 6, M 6.1 and M 6.2 are economically priced models without contact thermometer connection.

ECM 6: Smallest hotplate stirrer. The Eloxal hotplate is only 90x 90 mm and heats 200 ml water in ca. 13 min to 100°C. The brushless motor enables precise speed control from 10-1200 rpm.



Technical Data	M 6	M 6.1	M 6.2	ECM6
Speed range [1/min]	80 – 1600	80 – 1600	80 – 1600	10 – 1200
Temperature range [°C]	RT(+5°C) - 400	RT(+5°C) - 330	RT(+5°C) - 330	RT(+5°C) - 250
Heating power [W]	600	500	500	160
Heater plate diameter / dimensions [mm]	□ 135 x 135	○ 130	○ 140	□ 90 x 90
Heater plate	Ceran®	Stainless steel	Eloxal	Eloxal
Temperature control accuracy [°C]	± 5	± 10	± 10	± 1
Stirring quantity, max. (H ₂ O) [l]	10	10	10	1
External probe connection	-	-	-	-
PC interface	-	-	-	-
Power supply [V]	See: order information	See: order information	See: order information	See: order information
Weight [kg]	2.4	2.4	2.2	0.9
Dimensions [WxDxH mm]	155 x 160 x 110	155 x 160 x 115	155 x 160 x 110	100 x 110 x 83
Protection class according to DIN EN 60529	IP32	IP32	IP32	IP32

Order Information	Part Number			
230 VAC / 50Hz, EU plug (Type F)	60266-0000	60268-0000	60269-0000	60256-0000
115 VAC / 60Hz, USA plug (Type B)	60266-0001	60268-0001	60269-0001	60256-0001



Accessories	Part Number	Description
Probe support rod	60618-0000	Diameter: 8 mm, length: 350 mm
Probe clamp	8B005624	Stainless steel probe clamp
Crossover clamp	60668-0000	Stainless steel crossover clamp for support rod
Support rod holder	60669-0000	Holder for support rod (M6-Versions)
Support rod holder	60669-0010	Holder for support rod (ECM)

Round-bottom Flask Stirrers

- **Magnetic Hotplate stirrers for round-bottom flasks**
- **Programmable safety temperature**
- **External probe connection**
- **Control software available**



KM 16.4D / KM 16.7D

This heated magnetic stirrer is developed for heating round-bottom flasks as well as three-neck flasks. The heat transfer is done through radiation and direct surface contact with an aluminium block in the shape of round-bottom flasks. The heating block with the flask is surrounded by a stainless steel container. When breaking of glass occurs, the liquid is collected in a stainless steel container. The liquid is stirred by an oval stirring bar so that hot spots do not appear. Temperature ramping therefore is going smoothly. Different covers are delivered with the instrument so that the heat will remain in the stainless steel container. This improves fast heating.



Technical Data

	KM 16.4D	KM 16.7D
Speed range [1/min]	60 – 1100	60 – 1100
Temperature range [°C]	RT(+5°C) - 450	RT(+5°C) - 450
Heating power [W]	500	500
Heater plate diameter [mm]	SR 90 mm	SR 120 mm
Heater plate	Alu	Alu
Temperature control accuracy [°C]	± 1	± 1
Stirring quantity (round bottom flasks) [ml]	100, 200, 500	1000, 2000
Safety circuits	1	1
External probe connection	PT100 KTA	PT100 KTA
PC interface	RS485	RS485
Power supply [V]	See: order information	See: order information
Weight [kg]	3.2	3.4
Dimensions [WxHxD mm]	145 x 200 x 175	190 x 200 x 195
Protection class according to DIN EN 60529	IP32	IP32

Order Information

Part Number

230 VAC / 50Hz, EU plug (Type F)	60357-0000	60358-0000
115 VAC / 60Hz, USA plug (Type B)	60357-0001	60358-0001



60278-0000



60673-0000



61703-0000

Accessories	Part Number	Description
PT100	60278-0000	Temperature probe, diameter: 4 mm, sensor length: 240 mm.
Probe support rod	60663-0000	Diameter: 8 mm, length: 350 mm.
Probe clamp	8B005624	Stainless steel probe clamp.
Crossover clamp	60668-0000	Stainless steel crossover clamp.
RS485-RS232 adapter	61703-0000	Adapter for connection to RS232 PC interface.
RS232 extension cable	30275-0051	RS 232 extension cable 1.8 m
USB to RS232 adapter	30244-0001	USB adapter for connection to PC.
Software	Upon request	Control software for magnetic stirrers

Magnetic Stirrers



● **Very small footprint**



Basic magnetic stirrers

There is a choice of different models. They all have brushless motors with electronic feed-back speed control. This means changes in viscosity of the media or voltage fluctuation do not influence the set speed. A soft-start feature prevents stir-bar de-coupling.

ECM 2 and ECM 5: Compact, energy and space-saving magnetic stirrers. Early on Ingenieurbüro CAT recognised the need for space-saving stirrers in today's crowded laboratory environment. Also, people are becoming conscious that space-saving is important.

M 5 and M 15: Standard magnetic stirrer for general use.

M 20.20 and M 30.30: Magnetic stirrer especially designed for large volumes up to 100l.



Technical Data

	ECM 2	ECM 5	M 5
Speed range [1/min]	10 – 20	50 – 1200	60 – 1600
Set-up plate dimension [mm]	100 x 100	100 x 100	140 x 155
Stirring quantity, max. (H ₂ O) [l]	1	1	10
PC interface	-	-	-
Power consumption [W]	6	6	25
Power supply [V]	See: order information	See: order information	See: order information
Weight [kg]	0.7	0.7	1.8
Dimensions [WxDxH mm]	100 x 115 x 58	100 x 115 x 58	157 x 157 x 80
Protection class according to DIN EN 60529	IP32	IP32	IP32

Order Information

	Part Number		
230 VAC / 50Hz, EU plug (Type F)	60252-0000	60255-0000	60265-0000
115 VAC / 60Hz, USA plug (Type B)	-	-	60265-0001

- **Magnetic stirrer for versatile use**
- **Robust stainless steel housing**
- **Silent motor**



Technical Data

M 20.20

M 30.30

Speed range [1/min]	100 – 1100	100 – 1100
Set-up plate dimension [mm]	200 x 245	300 x 310
Stirring quantity, max. (H ₂ O) [l]	50	100
PC interface	-	-
Power consumption [W]	18	18
Power supply [V]	See: order information	See: order information
Weight [kg]	4.2	5.4
Dimensions [WxDxH mm]	215 x 245 x 110	310 x 315 x 170
Protection class according to DIN EN 60529	IP32	IP32

Order information

Part Number

24VDC / 25W	60253-0010	60254-0010
-------------	------------	------------

Hotplates

- **Universal laboratory heating bath**
- **Suitable for sand or oil temperature conditioning**



Hotplates for special applications

Sandbath H 4

A laboratory sandbath for heating sand, oil and other liquids, etc. The heating unit consists of a sealed IR-radiant enclosed in stainless steel. The sandbath itself is made of stainless steel and measures 140 x 140 x 55 mm with a capacity of over 1000ml. The temperature is regulated by a thermostat.

Slide drying bench H 15/30

This slide drying bench is used to dry specimen slides. It is designed for use in chemical and biological laboratories of industrial enterprises, universities and pharmacies. The temperature is provided by a built-in energy regulator controlling temperature up to 100 °C. The case and top are painted aluminium. Accepting up to 48 slides, it has the facility for drying slides in different orientations. They can be arranged on the bench in a number of ways with and without the welded support rod.

Hotplates H 3

Hotplates are mainly used to heat aqueous solutions in glass vessels without flammable contents. Since the hotplates of the units get very hot, it has to be determined by the user whether a dangerous situation may arise.



Technical Data	H 4	H 15/30
Temperature range [°C]	40 – 330	30 – 115
Heating power [W]	600	150
Heater plate diameter / dimensions [mm]	140 x 140 x 55	360 x 182
Heater plate material	Stainless steel	Coated aluminium
Temperature control accuracy [°C]	± 20	± 4
Power supply [V]	See: order information	See: order information
Weight [kg]	1.8	1.3
Dimensions [WxDxH mm]	155 x 157 x 165	186 x 395 x 105
Protection class according to DIN EN 60529	IP32	IP32

Order Information

Part Number

230 VAC / 50Hz, EU plug (Type F)

60224-0000

60229-0000



- **Unique slide drying bench**
- **Load capacity for up to 48 slides**

*Put your specimen slides
anyway you need*

- **Basic laboratory hotplates**
- **Robust stainless steel housing**
- **Small footprint**



Technical Data

H 3

H 3.1

Temperature range [°C]	40 – 400	40 – 330
Heating power [W]	600	500
Heater plate diameter / dimensions [mm]	□ 135 x 135	○ 130
Heater plate material	Ceran®	Stainless steel
Control accuracy [°C]	± 5	± 10
External probe connection	-	-
Timer	-	-
Safety control	-	-
Power supply [V]	See: order information	See: order information
Weight [kg]	1.7	1.5
Dimensions [WxDxH mm]	151 x 157 x 115	151 x 157 x 110
Protection class according to DIN EN 60529	IP32	IP32

Order Information

Part Number

230 VAC / 50Hz, EU plug (Type F)	60223-0000	60225-0000
115 VAC / 60Hz, USA plug (Type B)	60223-0001	60225-0001

Hotplates



- **Powerful laboratory hotplates**
- **Up to 2000W heating power**

Hotplates H 30/30, H 30/45

The surfaces of the hotplates will remain a flat even after many thermal shocks. This means there is optimum contact between hotplate and vessel to guarantee for an even heating of the liquid. A thermostatic temperature control unit allows for stepless temperature control. The thermostat stops the heat up procedure as soon as the set temperature has been reached. The desired temperature is set at the temperature control knob. A signal lamp indicates the operation of the hotplate. The lamp is illuminated as long as energy is supplied to reach the set temperature.



Technical Data

H 30/45

H 30/45C

	H 30/45	H 30/45C
Temperature range [°C]	40 – 350	40 – 400
Heating power [W]	2000	2000
Heater plate diameter / dimensions [mm]	450 x 300	450 x 300
Heater plate material	Aluminium	Ceran®
Temperature control accuracy [°C]	± 3	± 4
Power supply [V]	See: order information	See: order information
Weight [kg]	10.6	10.8
Dimensions [WxDxH mm]	465 x 315 x 145	465 x 315 x 150
Protection class according to DIN EN 60529	IP32	IP32

Order Information

Part Number

230 VAC / 50Hz, EU plug (Type F)

60226-0020

60226-0040

- **Powerful hotplates for higher requirements**
- **Programmable safety temperature**
- **External probe connection**
- **Control software available**



Hotplate H 30/30D

The H 30/30D hotplate features direct display and set of plate, probe and safety temperatures on the front panel of the instrument. Set temperatures, safety temperature as well as the programmable switch-off timer can be easily set via an incremental encoder wheel. All parameters can be monitored on a 4-digit LED-display. This hotplate has superb performance such as digital control of the liquid and hotplate temperatures for fastest heat up time without overshoot and temperature stability. This model is also available with RS485-interface which enables easy setting and readout of all relevant parameters.

Note: accessories see catalogue page 19 for M 26G2.



Technical Data	H 30/30	H 30/30C	H 30/30D
Temperature range [°C]	40 – 350	40 – 400	40 – 380
Heating power [W]	2000	2000	2000
Heater plate diameter / dimensions [mm]	300 x 300	300 x 300	300 x 300
Heater plate material	Aluminium	Ceran®	Aluminium
Temperature control accuracy [°C]	± 3	± 4	± 1 °C (with probe)
External probe connection	-	-	PT100 KTA
Timer	-	-	Programmable switch-off timer
Safety control	-	-	Programmable safety temperature
Power supply [V]	See: order information	See: order information	See: order information
Weight [kg]	7.6	7.6	7.4
Dimensions [WxDxH mm]	315 x 315 x 150	315 x 315 x 150	315 x 350 x 145
Protection class according to DIN EN 60529	IP32	IP32	IP32
Pc Interface	-	-	RS485

Order Information

Part Number

230 VAC / 50Hz, EU plug (Type F)	60226-0010	60226-0030	60226-0050
----------------------------------	------------	------------	------------

Roller Mixers

- **Roller mixers for daily laboratory routines**
- **Removable rollers**
- **Wide speed range**
- **Low voltage power supply**

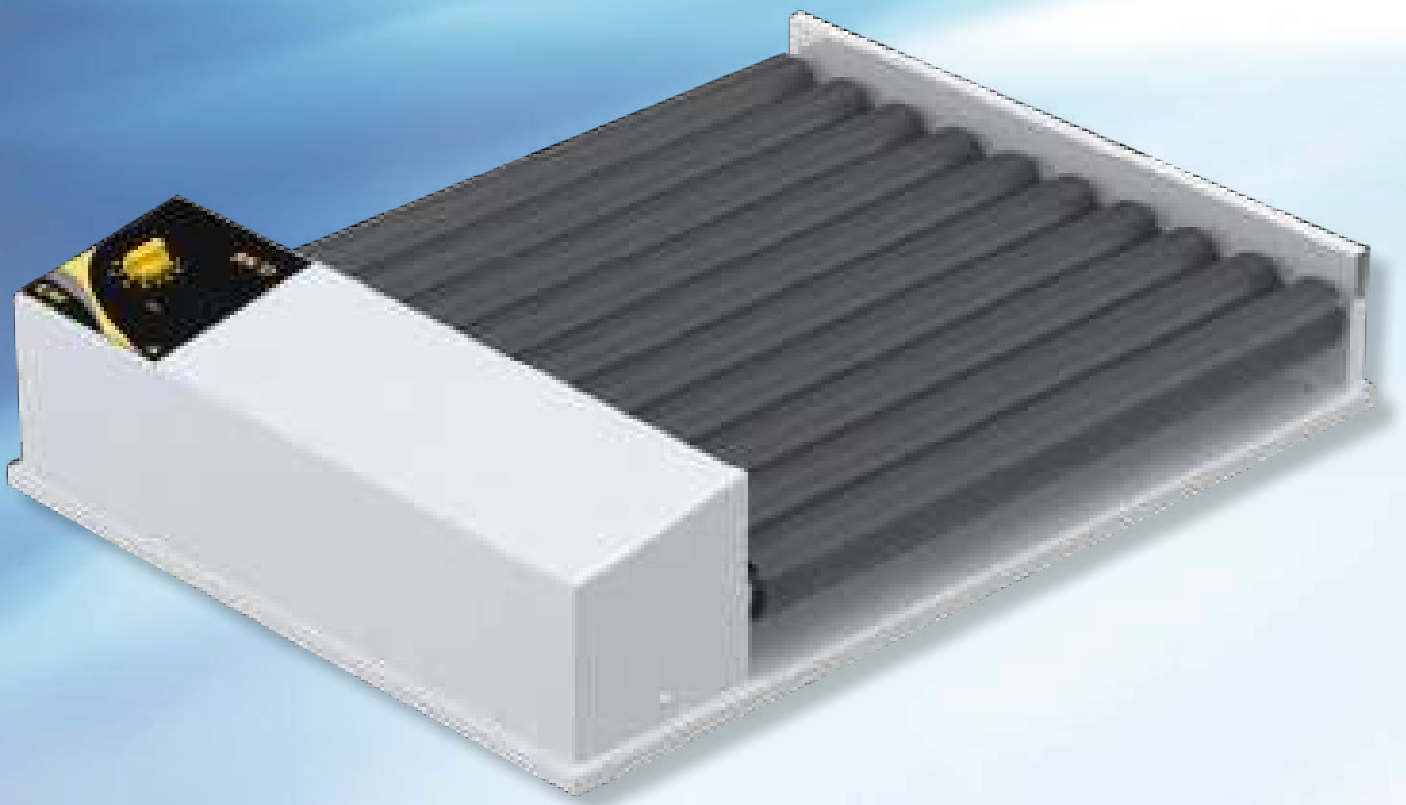

RM 5 / RM 10

Five or ten synchronized rotating PVC rollers provide a uniform and gentle swaying mixing of test tubes. Sufficient space allows for numerous test tubes to be placed horizontally along the surface of the oscillating rollers for simultaneous gentle and homogeneous mixing.

This kind of mixer is especially designed for the uniform mixing of medical laboratory tests of blood, haematological determinations and other cell suspension samples. In addition it prevents sedimentation in samples such as dyes, paints, oil and cosmetics, etc.

The models RM 5 and RM 10 have a 24 VDC drive, a power supply with connectors for EU, US, UK and AU is included. In these two models each roll can be removed individually without tools. These roller mixers move everything in your laboratory, from the test tube to 5l bottles.

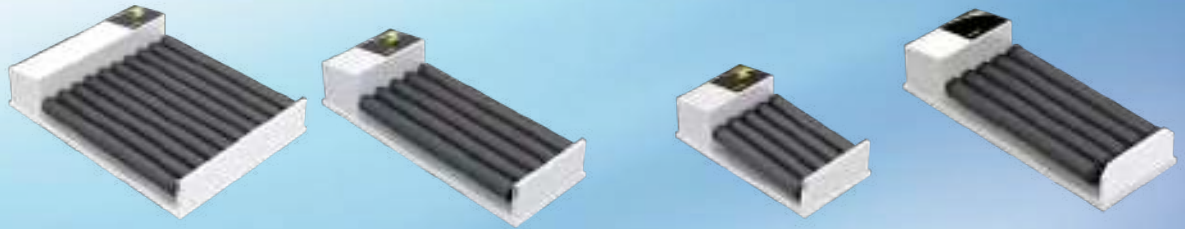

Technical Data	RM 10	RM 5	RM 5K	RM 5F
Speed range [1/min]	4 - 30 10 - 70	4 - 30 10 - 70	4 - 30	40
Length of rolls [mm]	330	330	216	334
Number of rolls	10	5	5	5
Removable rolls	Yes	Yes	No	No
Rolls material	PVC	PVC	PVC	PVC
Load, max. [kg]	5.0	5.0	5.0	5.0
Power supply [V]	See: order information	See: order information	See: order information	See: order information
Weight [kg]	6.5	3.7	3.0	3.7
Dimensions [WxDxH mm]	360 x 480 x 113	180 x 480 x 113	180 x 340 x 113	180 x 480 x 113
Protection class according to DIN EN 60529	IP 32	IP 32	IP 32	IP 32

Order Information	Part Number		
24 VDC (rpm: 10 - 70)	60207-0030	60207-0070	
24 VDC (rpm: 4 - 30)	60207-0100	60207-0110	60207-0060
24 VDC (rpm: 40)			60207-0020



Make it suitable for your needs

Accessories	Part Number	Description
Centric rolls	40207-0020	Centric rolls for horizontal rolling movement without tilting
Excentric rolls	40207-0010	Standard rolls for rolling and tilting movement

Orbital Shakers

- **Universal orbital laboratory shakers**
- **Wide range of shaking adapters**
- **Switch-off timer**
- **Robust stainless steel housing**



S 26 / S 20

S 26: This unit is especially designed to shake flasks for biological cultures and Erlenmeyer flasks in sizes of 250, 500 and 1000 ml. Other attachments are available. The microprocessor technique of this shaker provides for data transfer via the RS 232 interface for full computer control. The special indexing mechanism stops the shaking platform always at a defined position. The unit is driven by a brushless motor. These maintenance free motor is designed for continuous operation.

S 20: This shaker is a multi-use shaker which consists of a main drive unit and five different attachments for shaking various sizes and shapes of laboratory containers. Each attachment is sold separately making the shaker versatile for a wide range of individual laboratory needs.



Technical Data	S 20	S 26
Speed range [1/min]	100 - 1100	60 - 1100
Type of movement	orbital	orbital
Shaker orbit [mm]	3.0	3.0
Timer	Yes	Yes
Display	-	backlight LCD
Interface	-	RS232
Permissible load of platform, max. [kg]	3.0	1.5
Power supply [V]	See: order information	See: order information
Weight [kg]	4.1	6.9
Dimensions [WxDxH mm]	145 x 180 x 130	280 x 170 x 245
Protection class according to DIN EN 60529	IP 32	IP 32

Order Information	Part Number	
230 VAC / 50Hz, EU plug (Type F)	60283-0000	60386-0000
115 VAC / 60Hz, USA plug (Type B)	60283-0001	-

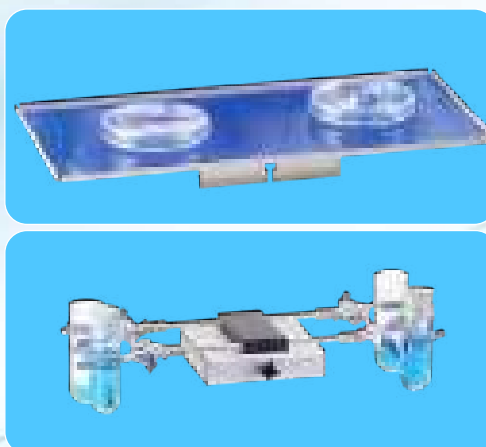

Accessories	Part Number	Description
S – Shaking adaptor	60648-0000	Shaking platform 200x400 mm with special adhesive mat. Recommended maximum shaking speed: 1000rpm. Dimensions: 370x150x45 mm
U – Shaking adaptor	60686-0000	Universal shaking adaptor for Erlenmeyer flasks and other bottles and containers. Recommended maximum speed: 500rpm. Dimensions: 350x150x125 mm
V – Shaking adaptor	60685-0000	Shaking adaptor for 4 Erlenmeyer Flasks or round-bottom flasks (500ml) Recommended maximum speed: 500rpm. Dimensions: 370x150x45 mm
R – Shaking adaptor	60687-0000	Test tube shaking adaptor for shaking up to 36 test tubes up to 16mm diameter. Recommended maximum speed: 800rpm. Dimensions: 190x140x145 mm
E – Shaking adaptor	60683-0000	Shaking adaptor for single hand held vessels up to 100ml. Recommended maximum speed: 1000rpm. Dimensions: 137x132x44 mm
2E - Shaking adaptor	60689-0030	Shaking adaptor for 2 Erlenmeyer flasks 1000 ml
4E - Shaking adaptor	60689-0020	Shaking adaptor for 4 Erlenmeyer flasks 500 ml
6E - Shaking adaptor	60689-0010	Shaking adaptor for 6 Erlenmeyer flasks 250 ml
RS232 extension cable	30275-0051	RS 232 extension cable 1.8 m
USB to RS232 adaptor	30244-0001	USB adaptor for connection PC to RS232 interface of shaker

Rocking Shakers

- **Rocking shakers for long time applications**
- **Adjustable tilt angle**
- **Silent motor drive**



- **Wrist arm shaker**
- **Load capacity up to 12 Erlenmeyer flasks**
- **Switch-off timer**



ST5 / S50 / VM 2

ST 5: The ST 5 rocking shaker comes with an illuminated „ON/OFF“ switch and a large platform (410 x 340mm) with a special anti-slip, adhesive mat for holding and gently rocking Petri dishes, microtiter plates and other small containers. The speed is electronically feed-back controlled with a range of 10 - 100 rpm oscillations per minute for continuous use. The rocker platform is designed to pivot in the middle axis and can be adjusted to give an angular tilt of 3, 6, 9 and 12°.

S 50: This „wrist arm shaker“ comes with two side arms and 8 three-finger alloy clamps to take up to 4 Erlenmeyer flasks à 1000 ml or 8 Erlenmeyer flasks à 500 ml for vigorous shaking needs. It simulates hand shaking movement and is designed for continuous run. With the analogue timer up to 60 minutes shaking action can be covered. After the set time has elapsed the shaking motion will stop. The shaking frequency can be set from 50 to 800 rpm. All joints of this unit have a ball bearing therefore no special maintenance is needed. The carbon brushes of the motor are designed for longevity.

VM 2: This small shaker is highly qualified for mixing operations of liquids in test tubes from the smallest size up to 30 mm in diameter. The shaking frequency is steplessly adjustable from 100 - 2800 rpm. The strong brushless motor with a precision centre balanced drive unit provides for quiet and trouble-free operation. The case is made of a stainless steel top and an acid proof steel body. With its dimensions of only 110 x 100 mm this unit finds space in every lab.



Technical Data	ST5	S 50	VM 2
Speed range [1/min]	10 – 100	50 – 800	100 – 2800
Type of movement	rocking	swivelling	orbital
Rocking angle [degree]	3, 6, 9, 12°	+/- 2°	-
Shaker orbit [mm]	-	-	3.0
Shaking platform dimensions [mm]	410 x 340	-	-
Shaking arm type	-	Arm for 4 clamps	-
Timer	-	60 min	-
Permissible load of shaker, max. [kg]	2.0	2.0 (per arm)	-
Power supply [V]	See: order information	See: order information	See: order information
Weight [kg]	3.9	8.2	1.1
Dimensions [WxDxH mm]	520 x 350 x 100	240 x 240 x 240	110 x 100 x 90
Protection class according to DIN EN 60529	IP 32	IP 32	IP 21

Order Information	Part Number		
230 VAC / 50Hz, EU plug (Type F)	60281-0000	60285-0000	60204-0000
115 VAC / 60Hz, USA plug (Type B)	-	60285-0001	60204-0001

- **Versatile vortex mixers**
- **Robust stainless steel housing**
- **Silent motor drive**
- **Very small footprint (VM 2)**

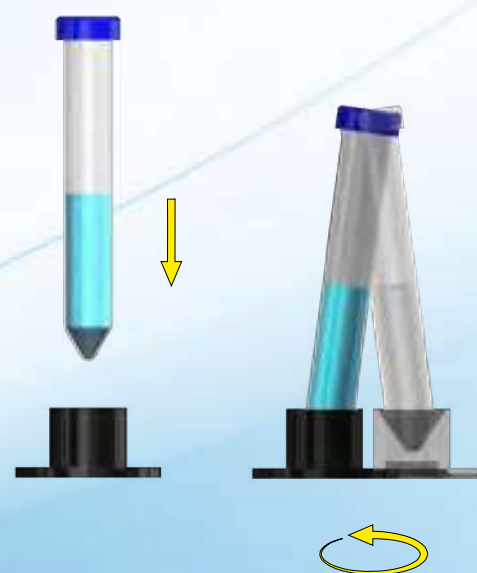

Operation control

Single-hand control: In switch position II, simply apply with slight pressure the test tube in the vertical direction on the receiving cup. The shaking motion is then activated according to the set speed. The motor is turned off as soon as the test tube is lifted from the receiving cup.

Continuous run: In switch position I the unit can be switched to continuous operation. The motor speed is steplessly adjustable, max. speed 2800 rpm.

Accessories	Part Number	Description
3-finger holding clamp	20285-0017	Three-finger holding clamp for shaking arm
Shaking arm for 6 clamps	10285-0057	Shaking arm for 6 holding clamps for shaking arm

Blood Cell Counter

- **Multi-function cell counter**
- **Tactile keyboard**
- **PC Interface**
- **Operation software**



DIFF 15

Compact, multi-function cell counter for manual differential counting procedures, e.g. bone, marrow, blood. Comes with RS232 interface, including software to transfer the data from the DIFF 15 to the computer and displays all percentage and total values for each key individually. Many laboratories want to store the data from the counter in their LIMS-System. For that, this software can handle the data on two ways: Store one or more different counts into a single data file or copy to clipboard.

Our software engineers have developed all software for our products. So it is possible to customize the software or do new development for your needs.

Hard-coded programs

Leuko: Up to 12 different cells can be included in the percentage calculation for leukocyte differentiation. The total sum can be selected between 100 and 1000 in stages of 100. Three single count keys are also available which are not included in the percentage calculation.

MYELO/RBC: Up to 15 different cells can be included in the percentage calculation for the differentiation of the myelogram and the red blood picture. The total can be selected between 100 and 1000 in stages of 100.

RETI: Only the Div/Reti and Div/Eri keys are available for the retikulocyte - erythrocyte ratio. Each press of the key may be set to 1/5/10/15/20/30/40/50 erythrocytes before the count commences. The result of the retikulocytes is displayed in 0/00. The automatic total is 1000.

Free selection program

FREE: This is a free selection program for which any key may be assigned as either a percentage calculation key or a single counting key.

Technical Data	DIFF 15
Number of entry keys	15
Number of programs	4
Hard-coded programs	Leuko MYELO/RBC RETI
Free selection program	1
PC Interface	USB
Protection class according to DIN EN 61140	II
Power supply [V]	See: order information
Weight [kg]	0.7
Dimensions [WxDxH mm]	165 x 210 x 25
Protection class according to DIN EN 60529	IP 32

Order Information	Part Number
230 VAC / 50Hz, EU plug (Type F)	60243-0000
115 VAC / 60Hz, USA plug (Type B)	60243-0001

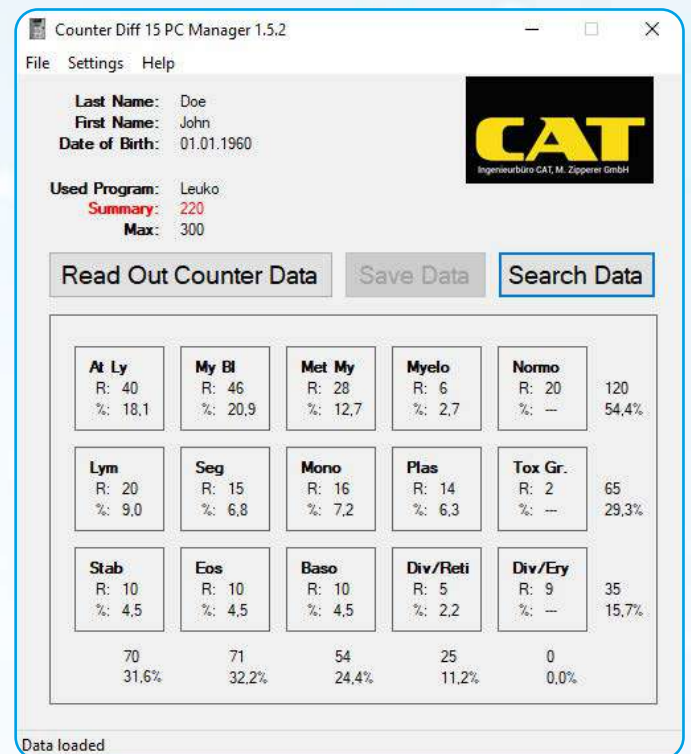

Operation Software

- **Patient information**
- **Database management**
- **Single count data**
- **Summary count data**

Accessories	Part Number	Description
RS232 interface cable	30275-0051	Interface cable 1.8m for connection to PC
Software	Included	Operation software for counter DIFF 15

Flask Burettes

- **High degree of reproducibility**
- **Dispensing volume from 1µl up to 1 l**
- **Electronical user calibration**
- **Especially designed for using with standard laboratory bottles**



*Use it like a burette
or like a dispenser*

Contiburettes

These Contiburettes enables to dispense liquid with high accuracy.

The great advantage of this design is its valve less construction, ensuring minimal dead volume.

These motor driven models have the option to preset volume and dosing speed. So they are usable as a burette or as a dispenser.

Small dimensions and a low weight prevent a top-heavy system. All wetted parts are made of Al₂O₃, ETFE or FEP, all provided with an excellent chemical resistance to almost all liquids in the lab. The Contiburettes are equipped with a calibration function to compensate the deviation of accuracy when using a liquid with a significant different density than water. A variety of reservoir adaptors allow for mounting to every laboratory bottle.

Standard applications: Burette, Dispenser.



Technical Data	μ 1D	μ 10D	μ 20D	μ 10H	μ 20H
Min. dispensing volume [μl]	1.0	10.0	20.0	10.0	20.0
Max. dispensing volume [ml]	50.0	500.0	1000.0	500.0	1000.0
Flowrate range [ml/min]	0.02 – 2.0	0.2 – 20.0	0.4 – 40.0	-	-
Drive mechanism	Motor	Motor	Motor	Hand	Hand
Dosing accuracy [%]	< ± 0.2	< ± 0.2	< ± 0.2	< ± 0.2	< ± 0.2
Coefficient of Variation, CV [%]	< ± 0.1	< ± 0.1	< ± 0.1	< ± 0.1	< ± 0.1
User Calibration	Yes	Yes	Yes	Yes	Yes
PC Interface	RS 485	RS 485	RS 485	-	-
Power supply	See: order information	See: order information	See: order information	See: order information	See: order information
Dimensions HxWxD [mm]	175 x 112 x 60	175 x 112 x 60	175 x 112 x 60	175 x 93 x 60	175 x 93 x 60
Pump head materials	Al ₂ O ₃ ETFE / FEP	Al ₂ O ₃ ETFE / FEP	Al ₂ O ₃ ETFE / FEP	Al ₂ O ₃ ETFE / FEP	Al ₂ O ₃ ETFE / FEP
Weight [kg]	0.56	0.56	0.57	0.39	0.40
Protection class according to DIN EN 60529	IP 43	IP 43	IP 43	IP 43	IP 43

Order Information	Part Number				
3 VDC (2 Batteries Type AA)	-	-	-	62723-0000	62724-0000
9 VDC (external power supply)	62730-0000	62732-0000	62734-0000	-	-



60703-0000



60704-0000



60707-0000

Accessories	Part Number	Description
A32-25	60703-0000	Flask adapter
A32-28	60704-0000	Flask adapter
A32-38	60705-0000	Flask adapter
A32-40	60706-0000	Flask adapter
A32-45	60707-0000	Flask adapter
RS485-RS232 adapter cable	61703-0000	Interface cable for connection of Contiburette to RS232 PC interface
Software	Upon request	Control software for contiburette

High Precision Pumps

- **Valve-less precision ceramic pump**
- **Highly inert ceramic pump head**
- **Integrated calibration function**
- **PC interface**



DP 200 - series pumps

High quality precise micrometering pumps with digital flow-rate control. The steel casing with only 72 mm width is acid-proof coated. This universal and easy to use laboratory pump is available with 20 μ l, 200 μ l or 350 μ l stroke volume. All dosing parameters (e.g. volume, flowrate, flow direction) are easily set by the keypad. The settings are stored in a non-volatile storage. The DP 200 has a RS 485 interface as standard to control it by an external unit (e.g. PC).

ISO 9001 and the GLP guidelines require regular checking and recalibration of measuring instruments. In order to facilitate and simplify this task, the DP 200 has an integrated calibration function.

Fluid contact surfaces are ceramic and fluorocarbon only. The pumpheads made of oxide ceramics are integrated into a stainless steel body or encased with fluoropolymers. The medium has only contact with the oxide ceramic and PVDF. This is also ensured for pumphead types with stainless steel bodies. Pumpheads with and without piston rinse ports are available.

Versions with other plastics (e.g. ETFE, PEEK) on demand.



Technical Data	Type 20	Type 200	Type 300
Min. dispensing volume [μ l]	1.0	10.0	20.0
Max. dispensing volume [ml]	50.0	500.0	1000.0
Flowrate range [ml/min]	0.02 – 4.0	0.2 – 40.0	0.4 – 60.0
Dosing accuracy [%]	< \pm 1.0	< \pm 1.0	< \pm 1.0
Coefficient of Variation, CV [%]	< \pm 1.0	< \pm 1.0	< \pm 1.0
User Calibration	Yes	Yes	Yes
PC Interface	RS 485	RS 485	RS 485
Power supply	24 VDC	24 VDC	24 VDC
Dimensions HxWxD [mm] W/O pump head	163 x 72 x 111	163 x 72 x 111	163 x 72 x 111
Pump head materials	Al ₂ O ₃ PVDF	Al ₂ O ₃ PVDF	Al ₂ O ₃ PVDF
Weight [kg]	1.5	1.5	1.5
Protection class according to DIN EN 60529	IP 43	IP 43	IP 43

Order Information	Part Number		
 T Ceramic encased with PVDF, without rinse port	61760-0000	61764-0000	-
 TCS Ceramic encased with PVDF, with rinse port integrated into ceramic	61761-0000	61765-0000	61768-0000
 V Ceramic encased with PVDF, integrated into stainless steel body, without rinse port	61762-0000	61766-0000	-
 VCS Ceramic encased with PVDF, integrated into stainless steel body, with rinse port integrated into ceramic	61763-0000	61767-0000	61769-0000

For all pump heads: wetted parts are only PVDF and ceramic (Al₂O₃, 99,7 %)

Accessories	Part Number	Description
RS485-RS232 adapter cable	61703-0000	Interface cable for direct connection to serial port
Power supply 24VDC	60738-0000	External power supply 24VDC, 100 – 240VAC
Software	Upon request	Control software for contiburette

Multichannel Pumps

- **Valve-less ceramic pump**
- **High degree of precision**
- **Large variety of pump heads available**

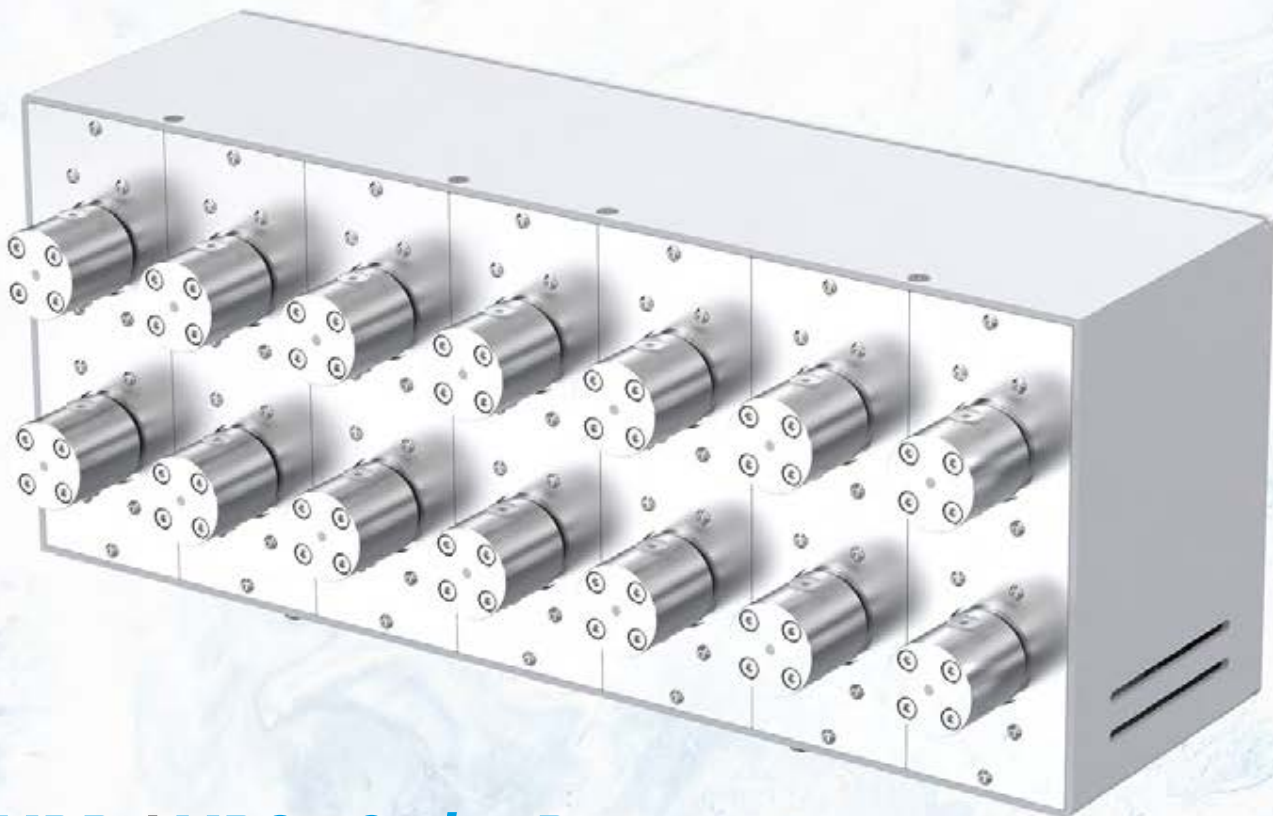

MDP / MPC - Series Pumps

The multi-channel pumps type MDP / MPC can be equipped with up to 14 pump modules and can be configured according to customer specifications. RS232 Interface allows control of pumps via PC. Every single pump module has its own slave address. Internally, all pump controllers are connected to an RS485 interface. This configuration allows individual operation of each pump module, as well as a simultaneous control of all pumps via the global slave address.

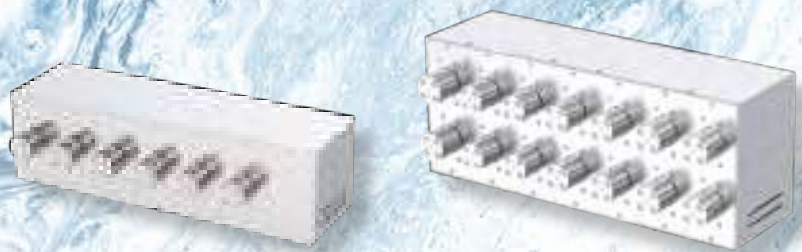

Technical Data		MDP	MDPS
Min. dispensing volume [ml]	Pump head	20	1
		100	10
		200	10
		300	20
		1000	-
Max. dispensing volume [l]	Pump head	20	50
		100	500
		200	500
		300	1000
		1000	-
Flowrate range [ml/min]	Pump head	20	0.02 – 4.0
		100	0.2 – 40.0
		200	0.2 – 40.0
		300	0.4 – 60.0
		1000	-
Inlet / Outlet connection	Pump head	20	UNF1/4"-28
		100	UNF1/4"-28
		200	UNF1/4"-28
		300	M8
		1000	-
Rinse port connection		UNF1/4"-28	UNF1/4"-28
Controller board		DP	DP
Number of pumps		1 - 6	1 - 14
Integrated rinsing pump		Upon request	Upon request
Dosing accuracy [%]		< ± 1.0	< ± 1.0
Coefficient of Variation, CV [%]		< ± 0.5	< ± 0.5
User Calibration		Yes	Yes
Interface		RS 232 RS 485	RS 232 RS 485
Power supply		24 VDC	24 VDC
Dimensions HxWxD [mm]		200 x 480 x 140	200 x 480 x 180
Pump head materials		Al ₂ O ₃ PVDF	Al ₂ O ₃ PVDF
Protection class according to DIN EN 60529		IP 42	IP 42

OEM Pumps



- **Valve-less ceramic pump**
- **High degree of precision and reproducibility**
- **Large variety of pump heads available**



OEM Pump Modules

For the development and construction of custom designed batches a variety of OEM solutions are available: E.g. ready assembled packages consisting of motor, ceramic pump and electronic controller with or without contactless pulse sensors and with or without pump rinse chambers optional in stainless steel cases. We also realize customer specific stroke volumes on short term notice.

To operate these pumps we offer a number of specially designed control boards. These boards provide easy control, programming and data entry and output.



Technical Data

DP 200-OEM

HPLH-OEM

Min. dispensing volume [µl]	Pump head	20	1	Depends on controller board
		100	10	
		200	10	
		300	20	
		1000	-	
Max. dispensing volume [ml]	Pump head	20	50	Depends on controller board
		100	500	
		200	500	
		300	1000	
		1000	-	
Flowrate range [ml/min]	Pump head	20	0.02 – 4.0	0.001 – 10
		100	0.2 – 40.0	-
		200	0.2 – 40.0	0.005 – 100
		300	0.4 – 60.0	0.01 – 150
		1000	-	0.03 – 400
Inlet / Outlet connection	Pump head	20	UNF1/4"-28	UNF1/4"-28
		100	UNF1/4"-28	-
		200	UNF1/4"-28	UNF1/4"-28
		300	M8	M8
		1000	-	M10
Rinse port connection		UNF1/4"-28	UNF1/4"-28	
Controller board		DP		
Dosing accuracy [%]		< ± 1.0		
Coefficient of Variation, CV [%]		< ± 0.5	Depends on controller board	
User Calibration		Yes		
Interface		RS 485		
Power supply		24 VDC		
Dimensions HxWxD [mm]		65 x 84 x 155	62 x 102 x 250	
Pump head materials		Al ₂ O ₃ PVDF	Al ₂ O ₃ PVDF	

Pump head type

Availability

	T	Pump head	20	●	●
			100	●	-
			200	●	●
			300	-	-
			1000	-	●
	TCS	Pump head	20	●	●
			100	●	-
			200	●	●
			300	●	●
			1000	-	-
	V	Pump head	20	●	●
			100	●	-
			200	●	●
			300	-	-
			1000	-	●
	VCS	Pump head	20	●	●
			100	●	-
			200	●	●
			300	●	●
			1000	-	-
	VS	Pump head	20	-	-
			100	-	-
			200	-	-
			300	-	-
			1000	-	●

Dispensing

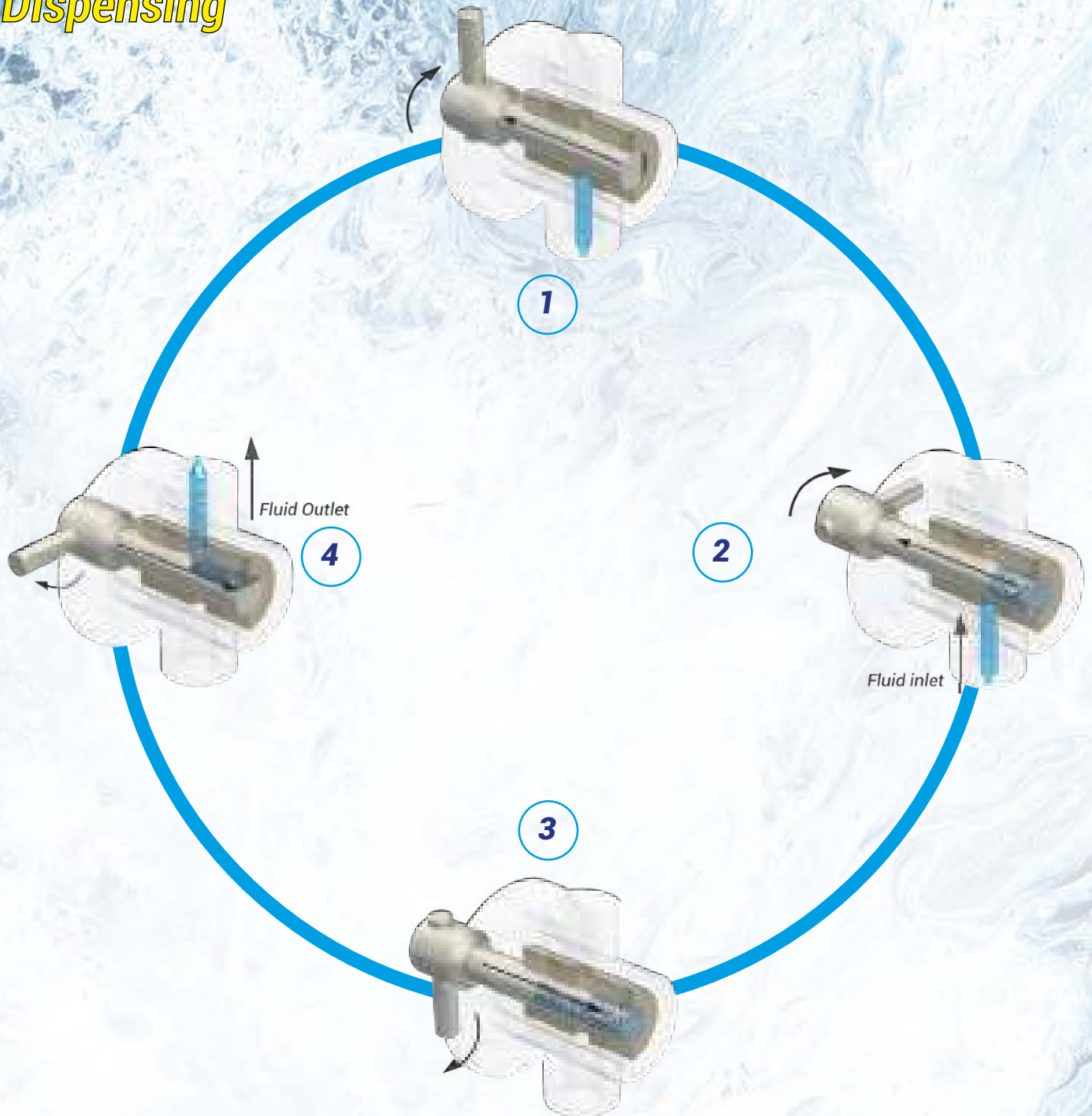

Positive displacement pumphead Principle of operation

- 1**
 - Piston shown at bottom dead center of its stroke
 - Inlet and outlet ports are closed
 - Piston flat rotating towards inlet port
- 2**
 - Piston shown at top dead center of stroke
 - Inlet and Outlet ports are closed
 - Piston flat is rotating toward outlet ports
- 3**
 - Suction is created during intake stroke
 - Piston flat opens inlet port to the pump chamber
 - Outlet port is closed
- 4**
 - Positive Displacement is created during discharge stroke
 - Piston flat opens outlet port to the pump chamber
 - Inlet port is closed

Accessories for dispensing systems

Accessories	Part number	Description
Fitting for 1.56 mm	10721-0001	Fitting for tube AD 1,56 mm ; 1/16", UNF ¼-28
Fitting for 3.00 mm	10721-0003	Fitting for tube AD 3.0 mm ; 1/8", UNF ¼-28
Fitting for 3.20 mm	10721-0003	Fitting for tube AD 3.2 mm ; 1/8", UNF ¼-28
M8 Connector	10721-0005	Pump head connector M8 for HPLH 300
M10 Connector	10738-0002	Pump head connector M10 for HPLH 1000
PTFE Tubing		
PTFE Tubing 1.60 mm	10758-0002	PTFE Tubing AD 1.6 mm, ID 1.0 mm, 1/16", Lenght: 1 m
PTFE Tubing 2.40 mm	10721-0020	PTFE Tubing AD 2.4 mm, ID 1.6 mm, Lenght: 1 m
PTFE Tubing 3.20 mm	10758-0001	PTFE Tubing AD 3.2 mm, ID 1.6 mm, 1/8", Lenght: 1 m
PTFE Tubing 5.00 mm	10291-0003	PTFE Tubing AD 5.0 mm, ID 4.0 mm, Lenght: 1 m
PTFE Tubing 6.00 mm	10291-0023	PTFE Tubing AD 6.0 mm, ID 4.0 mm, Lenght: 1 m
FEP Tubing 3.00 mm	10291-0019	FEP Tubing AD 3.0 mm, ID 2.0 mm, Lenght: 1 m
RS232 extension cable		
RS232 extension cable	30275-0051	RS232 cable 1.8 m
RS485-RS232 adapter cable		
RS485-RS232 adapter cable	61703-0000	Interface cable for connection of Contiburette to RS232 PC interface
Software		
Software	Upon request	Control software for liquid handling



20 CS
Ceramic



200
Ceramic

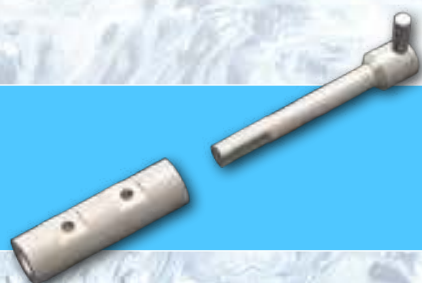

200 CS
Ceramic

Select ceramic pump head suitable for your application

Laboratory Automation

- **Customizable dimensions and hardware setup**
- **Free programmable moving sequences**
- **1, 2 or 3 axis system**
- **TTL, Relay and PC Interface**

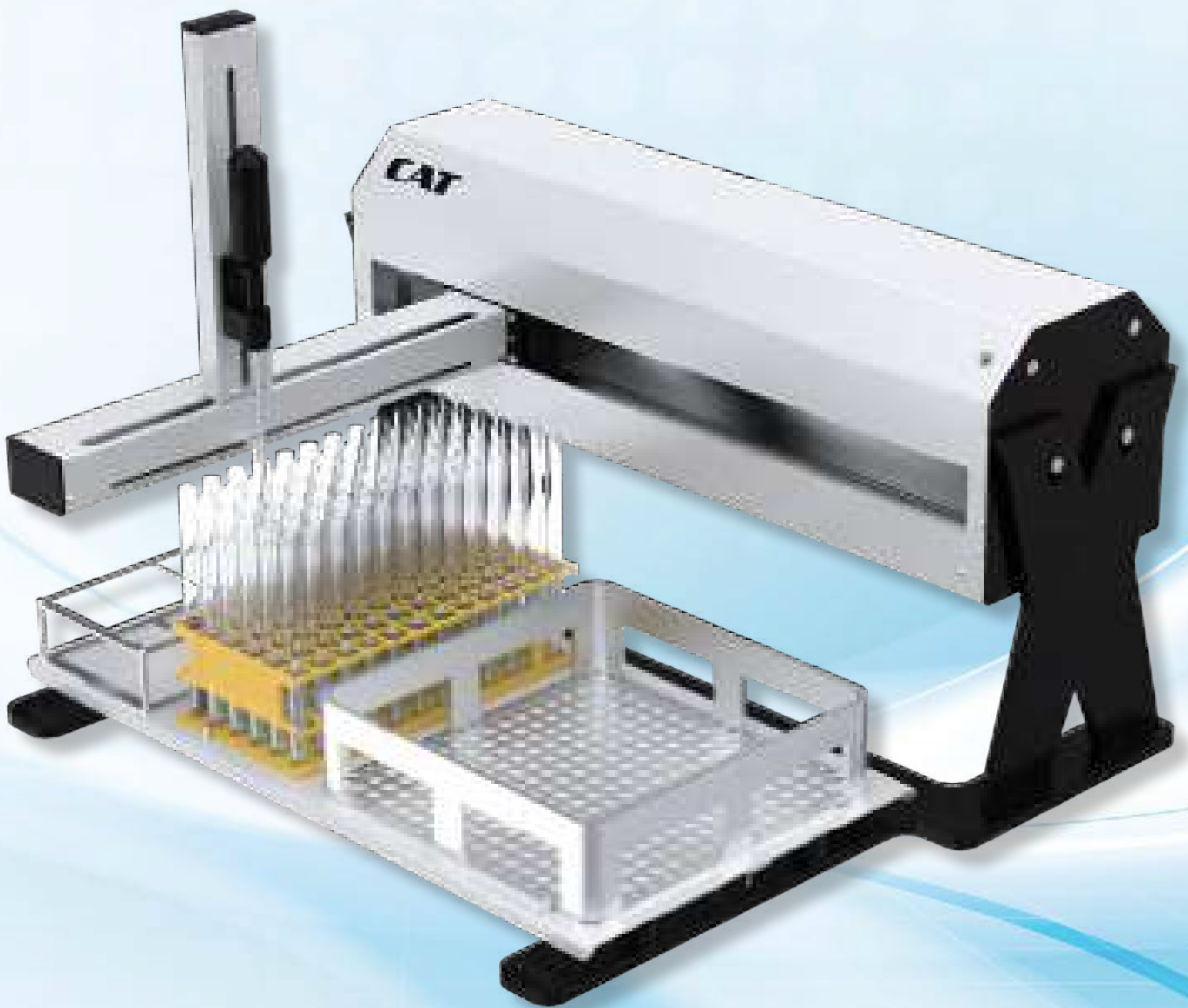

Scalable Laboratory Sampling System CaRo

CaRo is smart laboratory sampling system designed for daily laboratory routines. The device together with our micro-metering pumps provides fully automated liquid handling by using of control software. Multifunctional interface allowed integration of CaRo in different laboratory systems. CaRo system can be scaled suitable to client requirements and can be produced as an OEM version.



- *Control software available*
- *Positioning accuracy < 0.2mm*
- *Working area up to 550 x 300mm*



Laboratory Automation

- **Multi-channel sampling**
- **Dilution module**
- **Integrated high precision pumps**
- **Up to 12 sampling channels**



Dissolution Sampling System DSR

The unique offline dissolution sampling system that was specially designed for using with tablet dissolution bath. The DSR can provide sample collection from 6 to 12 vessel. High precision valve-less ceramic pumps are integrated into DSR. The system can be completed with dilution and media refilling modules. The display shows all actual process information. The own controller board allows to set customized process and hardware setup data.

Applications: Tablet dissolution Test, Dilution, Media addition.



Integrated Pump Module



Test Columns

- **Versatile usage**
- **Intergrated nylon filter (TC 50)**
- **Acrylic glass tube**
- **Standard tubing connectors**



- **Modular design: 1 to 8 test channel**
- **Logging of process data**
- **Free programmable application settings**
- **PC controlled or offline application process**

Leaching Test Columns

Highly inert and robust column for leaching test. The sample tube is made out of acrylic glass. This improves acid-base property and increases thermal resistance. All parts, which are in contact with the sample, are made out of acrylic glass, PVDF and Viton. The TC 50 columns are equipped with 10 μ m inlet and outlet nylon filters. The test columns was designed for using for Leaching Test and for similar applications (NEN 7343, DIN 19528, DIN EN 14405).



Technical Data

	TC 50	TC 100
Sample tube inner diameter [mm]	Ø 50	Ø 100
Sample filling height, max [mm]	250	450
Sample tube material	Acrylic glass	Acrylic glass
Inlet / outlet connection	¼"-28	¼"-28
Inlet / outlet filter	10µm	-
Filter material	Nylon	-
Dimensions [mm]	Ø 50 x 390-520 mm	Ø 100 x 560-720 mm
Weight [kg]	0.8	2.5

Order Information

Part Number

61706-0000

61708-0000

Modular Automatic Column Test System

Fully automatic modular system for leaching test or percolation column test regard to NEN 7343, DIN 19528 and DIN EN 14405. The number and the type of pumps and test columns can be selected due to client requirements. The control modul Supports up to 8 test channels. Each test channel consists of one pump and automatic multichannel valves (4- or 7-way valves).



По вопросам продаж и поддержки обращайтесь:

Алматы (727)345-47-04
Ангарск (3955)60-70-56
Архангельск (8182)63-90-72
Астрахань (8512)99-46-04
Барнаул (3852)73-04-60
Белгород (4722)40-23-64
Благовещенск (4162)22-76-07
Брянск (4832)59-03-52
Владивосток (423)249-28-31
Владикавказ (8672)28-90-48
Владимир (4922)49-43-18
Волгоград (844)278-03-48
Вологда (8172)26-41-59
Воронеж (473)204-51-73
Екатеринбург (343)384-55-89

Иваново (4932)77-34-06
Ижевск (3412)26-03-58
Иркутск (395)279-98-46
Казань (843)206-01-48
Калининград (4012)72-03-81
Калуга (4842)92-23-67
Кемерово (3842)65-04-62
Киров (8332)68-02-04
Коломна (4966)23-41-49
Кострома (4942)77-07-48
Краснодар (861)203-40-90
Красноярск (391)204-63-61
Курск (4712)77-13-04
Курган (3522)50-90-47
Липецк (4742)52-20-81

Магнитогорск (3519)55-03-13
Москва (495)268-04-70
Мурманск (8152)59-64-93
Набережные Челны (8552)20-53-41
Нижний Новгород (831)429-08-12
Новокузнецк (3843)20-46-81
Ноябрьск (3496)41-32-12
Новосибирск (383)227-86-73
Омск (3812)21-46-40
Орел (4862)44-53-42
Оренбург (3532)37-68-04
Пенза (8412)22-31-16
Петрозаводск (8142)55-98-37
Псков (8112)59-10-37
Пермь (342)205-81-47

Ростов-на-Дону (863)308-18-15
Рязань (4912)46-61-64
Самара (846)206-03-16
Санкт-Петербург (812)309-46-40
Саратов (845)249-38-78
Севастополь (8692)22-31-93
Саранск (8342)22-96-24
Симферополь (3652)67-13-56
Смоленск (4812)29-41-54
Сочи (862)225-72-31
Ставрополь (8652)20-65-13
Сургут (3462)77-98-35
Сыктывкар (8212)25-95-17
Тамбов (4752)50-40-97
Тверь (4822)63-31-35

Тольятти (8482)63-91-07
Томск (3822)98-41-53
Тула (4872)33-79-87
Тюмень (3452)66-21-18
Ульяновск (8422)24-23-59
Улан-Удэ (3012)59-97-51
Уфа (347)229-48-12
Хабаровск (4212)92-98-04
Чебоксары (8352)28-53-07
Челябинск (351)202-03-61
Череповец (8202)49-02-64
Чита (3022)38-34-83
Якутск (4112)23-90-97
Ярославль (4852)69-52-93

Россия +7(495)268-04-70

Казахстан +7(727)345-47-04

Беларусь +(375)257-127-884

Узбекистан +998(71)205-18-59

Киргизия +996(312)96-26-47

эл.почта: cgb@nt-rt.ru || сайт: <https://cat-ing.nt-rt.ru/>